

## REF.1470X/1481X WIT MONITOR

WIT is a capacitive touch screen monitor available in 7" and 10" versions. WIT graphical interface provides an intuitive user experience since it is design focused on a residential intercom use.

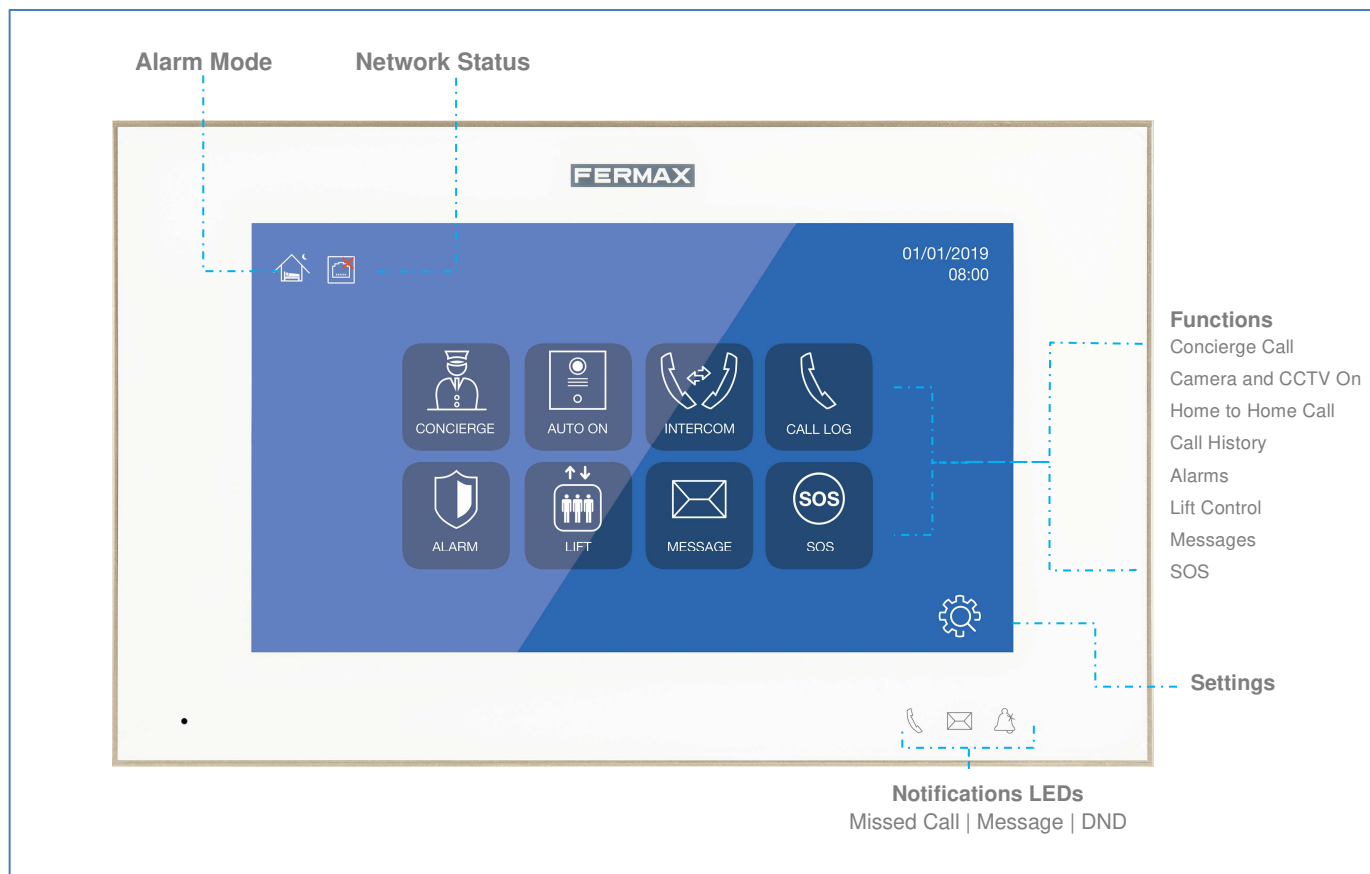

### FEATURES

- Capacitive Touch Screen (7" / 10")
- Hands Free Audio Communication
- High-definition colour TFT
- Different ringtones depending on call source
- 2 Different colour options (White and black)
- Remote firmware upgrade
- Android based
- Available in 9 languages (English, Spanish, German, Polish, French, Chinese, Russian, Turkish, Hebrew)
- Remotely reset and factory settings
- Intercommunication between monitors in the same apartment
- Device identification by means of TAGS.
- Door bell connection with IP camera visualization
- IP CCTV visualization (up to 8)
- Aux IP CCTV camera visualization and aux relay operation during call (up to 4 relays from Module Ref. 1491 connected to a MILO DIGITAL or KIN panel).
- Relay activation (up to 8 using relay module)
- Home Automation Ready through Apps (in 7" and 10")
- Automatic and Manual Picture Capture
- Integrated 7 zones alarm + tamper
- SIP compatible
- Lift control with feedback

## FUNCTIONS

---



### 1. CONCIERGE

Users can call the desired concierge by selecting it on the list shown in the user interface. If the concierge has a camera attached a video communication will be established, otherwise only audio.



### 2. PANEL AND CCTV CAMERA AUTO ON

Users can open the panel's video channel of their respective block for surveillance purpose. Once the panel communication is established, the user can take pictures, talk, and open the door if wanted. The pictures can be exported to a micro SD card.

There is also possible to supervise the authorized CCTV cameras. This feature can be disabled by the installer.

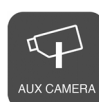

### 3. AUX CAMERA AND AUX DOOR LOCK RELEASE DURING CONVERSATION

When a call is received from the panel, it is possible to display different aux cameras (up to 4) to get a different angle of view or to follow the visitor. At the same time different aux relays (up to 4) can be activated to open additional gates or barriers.



### 4. VIDEO DOORBELL

It is possible to connect a pushbutton to the monitor so it will trigger the doorbell sound on the monitor. The doorbell call can automatically display the video coming from an IP CCTV camera, increasing the security.



### 5. HOME TO HOME CALL AND

The monitor allows the users to call different apartments within the same community and call a monitor in the same apartment as well. These features can be disabled by the installer.



### 6. CALL LOG

Users can have a clear view of their call history in the CALL LOG interface and are able to browse through the pictures taken for each call. There is possible an individual or a complete deleting of the registers.



### 7. PHOTO CAPTURE

When receiving a call, it is possible to automatically capture a photo. It is possible to take additional photos if desired. This feature can be disabled by the installer.



### 8. MESSAGES

Users can receive text messages from their property management so they can easily know if there is a package, a maintenance schedule, or an import event on their community (software management required). Maximum 64 messages. This feature can be disabled by the installer.



### 9. LIFT CONTROL

Tenants can enable the lift to their visitors to access their floor at the same time the panel door lock is opened from the monitor. Tenants can call the lift before leaving their apartment, so the lift car is ready on the floor. This feature can be disabled by the installer.



### 10. ALARMS

The monitor provides 7 alarm zones management, managed under 3 simple modes: HOME: Lowest Security level. SLEEP: Medium Security level. OUT: Highest Security level.

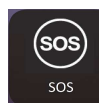

### 11. SOS

User generates an SOS alarm by touching this icon several seconds, sending a message to the concierge and management software.

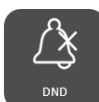

### 12. DO NOT DISTURB

It is possible to set the monitor to DO NOT DISTURB mode, so the calls will not produce any sound during a defined period of time. Do not disturb led will light up if this function is active.

## TECHNICAL SPECIFICATIONS

### System:

- CPU: Quad-core
- FLASH: 4GB
- SDRAM: 512 MB

### Screen:

- 7 and 10 inch format
- Capacitive touch screen
- Format: 16:9
- Resolution: 1024x600
- Brightness: 7" 200cd/m2; 10" 220cd/m2
- Contrast: 7" 400/1; 10" 450/1
- View Angle: 7" 160° Horizontal, 130° vertical; 10" 120° Horizontal, 110° Vertical

### Audio/Video Features:

- G.711 audio codec
- H.264 video codec
- RTSP compatible for CCTV IP cameras
- Audio level adjustable on conversation and mute
- Hands-free operation
- Private communication
- Selectable call melodies based on call origin

### Power Consumption:

- On standby: 200 mA (7") / 210 mA (10")
- Conversation: 500 mA (7") / 600 mA (10")

### Working voltage:

- PoE
- 12 Vdc

### Connectivity:

- 1 x Ethernet RJ-45 (WIT 7")
- 2 x Ethernet RJ-45 (WIT 10") for building and apartment network isolation.
- Doorbell input (1 alarm zone input)
- Panic button input (1 alarm zone input)
- Built in web server for configuration and remote management

### Working Environment:

- Temperature: -10° C +55° C
- Humidity: 20 – 85% (Non-condensing)
- IP: 30

## REFERENCES

	WIT 7"		WIT 10"
14701	WIT 7" MONITOR POE WHITE	14811	WIT 10" HOME AUT. MONITOR POE WHITE
9541	WIT / MIO CONNECTOR	1489	WIT 10" WALL FLUSH BOX

## DIMENSIONS

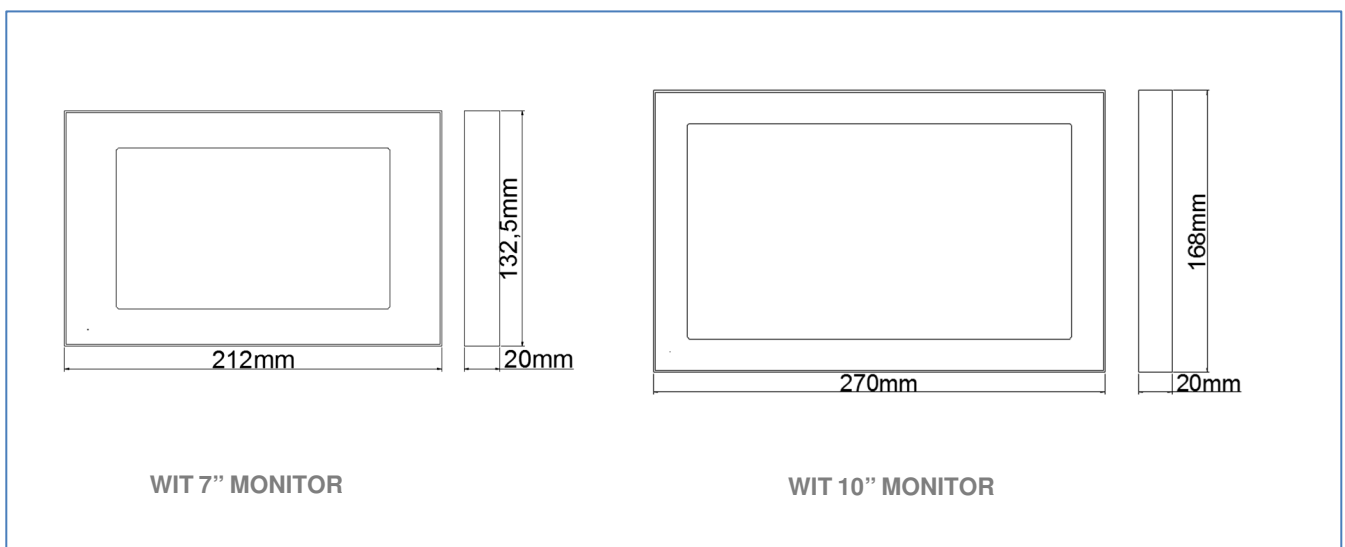

## CONNECTIONS

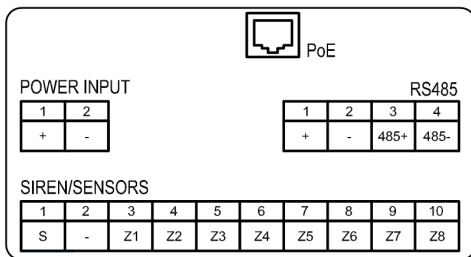

### WIT 7"

**RJ-45 10/100 Base -T Ethernet/PoE**

**1-2 (+, -): 12 Vdc.** Power supply input

**1-4 (+, -, 485+, 485-):** 12 Vdc Output; RS485 serial port

**1 (S):** 12 Vdc for auxiliary siren

**2 (-):** Negative common for alarms

**3-10 (Z1 – Z8):** For alarm sensors connection

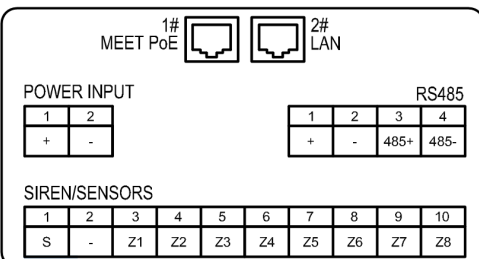

### WIT 10"

**2 x RJ-45 10/100 Base -T Ethernet/PoE**

**1-2 (+, -): 12 Vdc.** Power supply input

**1-4 (+, -, 485+, 485-):** 12 Vdc Output; RS485 serial port

**1 (S):** 12 Vdc for auxiliary siren

**2 (-):** Negative common for alarms

**3-10 (Z1 – Z8):** For alarm sensors connection

## INSTALLATION

### Surface installation (WIT 7" and WIT 10" monitor)

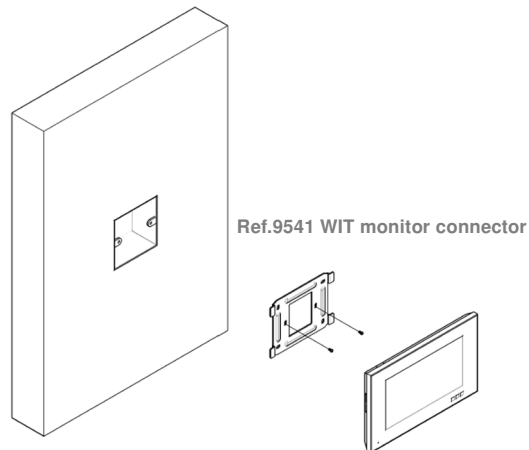

### Flush installation (only WIT 10")

