

MEET

MIO / WIT MONITOR

FERMAX

INSTALLER MANUAL



CONGRATULATIONS FOR BUYING A QUALITY PRODUCT!

Fermax Electrónica develops and manufactures premium equipment that meets the highest design and technology standards. We hope you will enjoy all its functions.

Technical publication for information purposes edited by FERMAX ELECTRÓNICA S.A.U.







FERMAX ELECTRÓNICA applies a continuous improvement policy, therefore it reserves the right to modify the contents of this document, as well as the product features hereof at any time and without prior notice. Any modification will be reflected in subsequent editions of this document.

This product is protected with the following patents and utility models:

PATENTS: US 9215410, US 9762852, BE1023440, AU2014203706.

UTILITY MODELS: ES1187384U, ES1141495U, FR3038192, DE202016000632U1, CN205987229(U).

INDEX

	1. DESCRIPTION	4
<hr/>		
	2. INSTALLATION	5
	2.1. Stand placement	5
	2.2. Attaching the monitor to the stand	5
	2.3. Configuring diagram	6
	2.4. Wired alarm and doorbell sensors	6
	2.5. Wiring of FERMAX MEET Relay Module Ref. 1616	7
<hr/>		
	3. TECHNICAL SPECIFICATIONS	8
<hr/>		
	4. LOCAL PROGRAMMING FROM THE MONITOR	9
	4.1. Installer access	9
	4.2. Basic configuration of the MONITOR	10
	4.3. Configuring the alarm settings	12
	4.4. Enable/disable FUNCTIONS	13
	4.5. Enable/disable FUNCTIONS ICONS on the monitor	13
	4.6. Change of PASSWORDS	14
<hr/>		
	5. WEB BROWSER PROGRAMMING	15
	5.1. Device	16
	5.2. General	16
	5.3. Network configuration	16
	5.4. IP Camera	17
	5.5. SIP	18
	5.6. Advance	19
	5.7. Actuators	20
	5.8. Check	20
	5.9. Pin Code	20
	5.10. Restore	21
<hr/>		
	6. ANNEXES	22
	6.1. Installation of third party applications	22
	6.2. Firmware updates	22
<hr/>		
	7. REGULATIONS AND CERTIFICATION	25
<hr/>		



DESCRIPTION

The following document is the Installation Manual for the FERMAX MEET range monitors, corresponding to the references indicated below and with firmware V03.00.

- REF. 952201 MONITOR MIO WHITE 7"
- REF. 952203 MONITOR MIO BLACK 7"
- REF. 952701 MONITOR MIO WHITE 10"
- REF. 952703 MONITOR MIO BLACK 10"
- REF. 14701 MONITOR WIT 7" POE WHITE
- REF. 14703 MONITOR WIT 7" POE BLACK
- REF. 14811 MONITOR WIT 10" POE WHITE DOMOTICO
- REF. 14813 MONITOR WIT 10" POE BLACK DOMOTICO

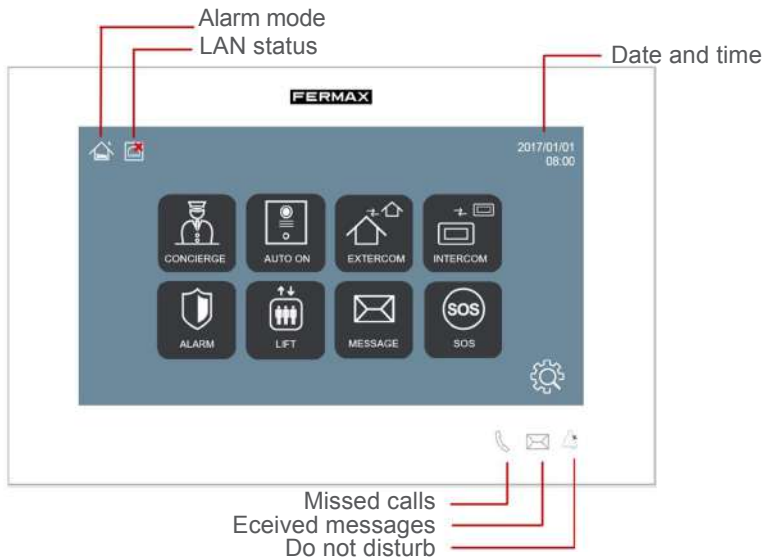



2 INSTALLATION

2.1. STAND PLACEMENT

Before installing the MEET monitor, the corresponding installation stand must be placed on the wall.

This stand must be screwed on covering the box or conduit where the cable or cables connecting to the monitor (ethernet cable, power supply and accessories, if any) arrive. Use the screws and plugs supplied with the monitor to attach the stand.

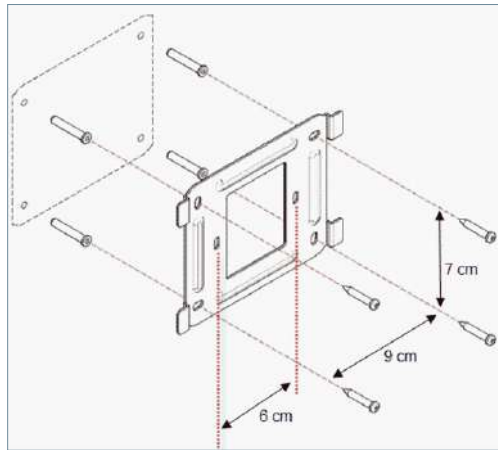

2.2. ATTACHING THE MONITOR TO THE STAND

Once the stand is in place, proceed to hang the monitor.

To do this, snap the 4 connector anchors into the corresponding slots on the back of the monitor and push down on the monitor to attach it.

Don't forget to pre-connect the ethernet network connectors, power supply and accessories, if applicable.

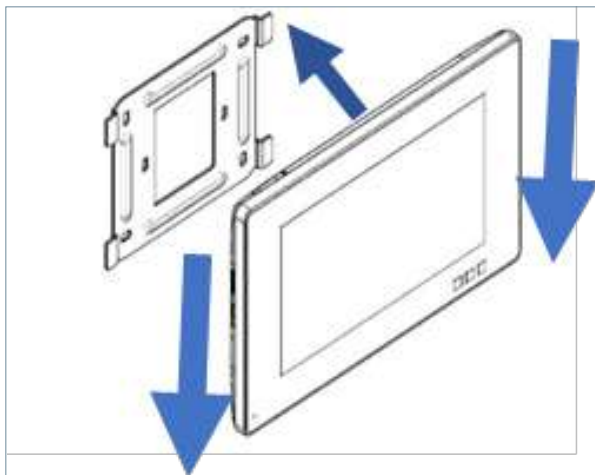

2.3. CONFIGURING DIAGRAM

The MEET monitor is connected to the installation by means of connectors: ethernet for LAN connection and MOLEX type connectors for other connections (power supply, RS-485 and sensor inputs).

A bag containing the corresponding male plugs with their cables is enclosed with the monitor's connector.

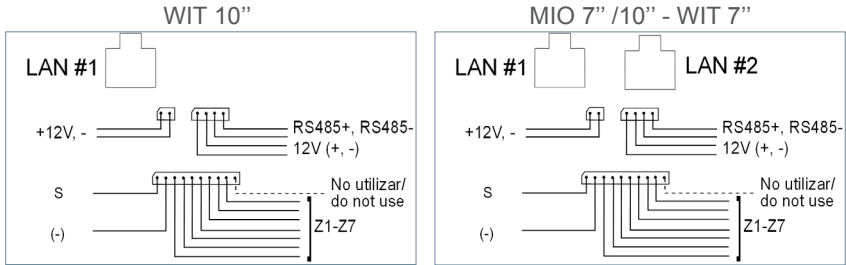

- **LAN#1:** Ethernet connector to the building's LAN installation. PoE for WIT monitors. No PoE for MIO monitors.
- **LAN#2:** Ethernet connector to the home's local LAN installation. Only WIT 10" monitor.
- **+12V:** 12 Vcc power input for non-PoE installations.
- **Siren / Sensors:**
 - **S:** 12 Vdc auxiliary output synchronised with the activation of any sensor. The maximum current is 100 mA.
 - **-:** GND.
 - **Z1-Z7:** sensor inputs. Z8 is reserved for tamper.
- **12V +, -, 485+, 485-:** Power output and RS-485 connection for the 10 Relay Module Ref. 1616.

NOTE: LAN#2 connection requires a DHCP server, as it is not possible to assign an IP address from the monitor.

2.4. WIRED ALARM AND DOORBELL SENSORS

Wiring diagram, normally open sensor.

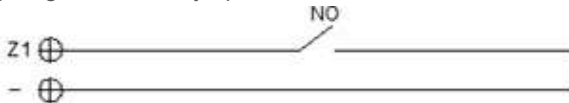

Wiring diagram, normally closed sensor.

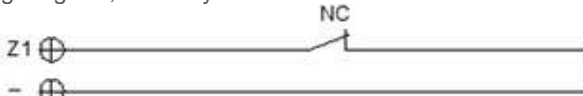

Wiring diagram, normally open sensor, option 3C.

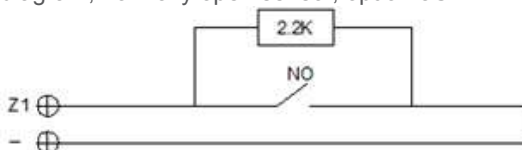

Wiring diagram, normally closed sensor, option 3C.

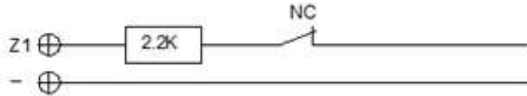

Wiring diagram, doorbell.

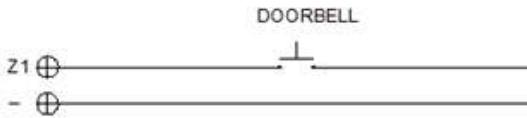

NOTE:

Option 3C consists of a monitoring system via which the monitor would detect sabotage in the sensor loop (shorting or cutting the sensor loop).

To enable this option, connect a 2.2 KOhm resistor according to the diagram and enable the 3C function in the monitor (See section 4.3 Configuring the alarm settings).

A bag with 8 resistors is included with the monitor.

Triggering any sensor activates the S output for 5 minutes, except when configured as a doorbell.

The Z8 sensor input is reserved for the internal tamper (monitor anti-sabotage).

2.5. WIRING OF FERMAX MEET RELAY MODULE REF. 1616

To use the actuator control option, a FERMAX MEET Relay Decoder Ref. 1616 must be installed.

The connection to the monitor is through the RS-485 connector as shown in the following diagram.

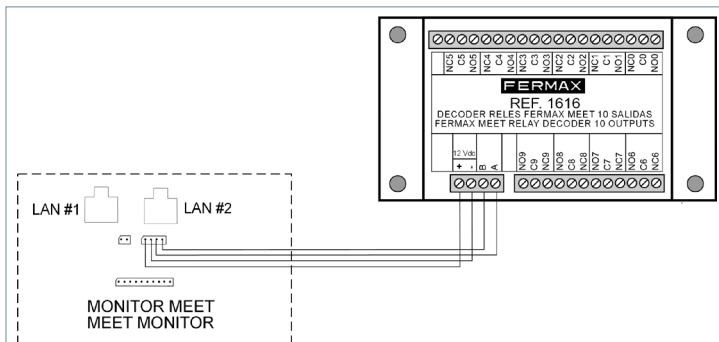

To activate the devices to be controlled, use the relay outputs 1 to 8, corresponding to the activations R1 to R8 of the monitor control screen. Relay outputs 0 and 9 are not used.

The module Ref. 1616 is powered directly from the monitor. No additional power is required.

NOTES:

The module Ref. 1616 only activates the corresponding relay during the time indicated in the programming (between 1 and 60 seconds). After this time, the relay automatically returns to standby.

No relay status is displayed on the monitor.



TECHNICAL SPECIFICATIONS

Dimensions (mm)		
MIO 7" Monitor	210 (W.) × 130 (H) × 20 (D)	
WIT 7" Monitor	211 (An.) × 132 (Al) × 20 (P)	
MIO 10" Monitor	270 (An.) × 168 (Al) × 20 (P)	
WIT 10" Monitor	210 (An.) × 168 (Al) × 20 (P)	
Power supply		
MIO Monitor	12 Vdc o PoE	
WIT Monitor	12 Vdc / PoE	
Consumo		
Monitor MIO	- idle current	200 mA
	- working current	500 mA
Monitor MIO	- idle current	210 mA
	- working current	600 mA
Resolution	1024x600 píxeles	
Touch screen	Capacitive technology	
Maximum time to answer the call	120 seg.	
Maximum auto-on time	30 seg.	
Maximum recording log	64.	
Maximum number of IP cameras	8	
Block	001-999	
Apartment	0001-9899	
Working temperature	- 10°C ~ 55° C	
•Relative humidity	20-85% (without condensation)	



LOCAL PROGRAMMING FROM THE MONITOR

MEET monitors allow the programming of basic configuration parameters (block identification, housing, IP address, etc.) through their own interface and without using a PC, so that it is possible to leave it ready to complete its configuration later via the web browser.

All MEET monitors leave the factory with the same default IP address (10.1.1.1). In order to access them remotely via web browser, it is necessary to assign them a unique IP address, according to the requirements of the LAN.

It is therefore necessary to carry out prior planning of the installation, with the IP address to be assigned to each and every one of the components of the installation (monitors, panels and guard units).

4.1. INSTALLER ACCESS

From the idle screen, access the installer section by touching the icon .

Touch the icon  to access the programming parameters through the interface of the monitor itself.

Identify yourself by entering the INSTALLER PIN through the keypad:



The default INSTALLER PIN is 6666.



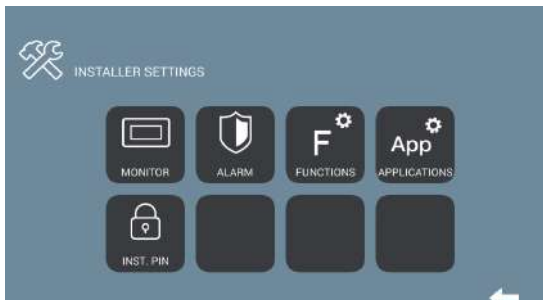

It can be changed later for another of your choice.

For security reasons, if the wrong PIN is entered three times in a row, the device will be blocked for 60 seconds.

Once the correct PIN has been entered, the INSTALLATION SETTINGS options will appear:



The options available from this section are:

	Basic monitor configuration (IP addressing, LAN configuration, block, housing, etc.)
	Configuring the built-in alarm settings
	Enable/disable user functions
	Installation of third party APPs and other MEET APPs such as Lift Control or actuators
	Change the INSTALLER PIN code

4.2. BASIC CONFIGURATION OF THE MONITOR

Touch the icon  to access the basic configuration parameters:



Use the keyboard that will appear on the screen to enter the corresponding programming parameters.

MONITOR SETTINGS

- **BLOCK:** Block number of the apartment where the monitor is installed
- **APARTMENT:** Number of the apartment where the monitor is installed
- **MONITOR:** Number (from 0 to 9) assigned to each of the monitors installed in the same apartment, in the case that there are more than one. Otherwise, leave the default value “0”.
- **SYNC CODE:** Synchronisation code with the rest of the devices in the installation. Default value is 123456.
- **IP SOFTWARE:** IP address of the PC where the MEET Management Software is installed (if any).
- **SW PIN:** Management Program ACCESS PIN code. The default option is 123456.

NETWORK SETTINGS

- **IP:** IP address to be assigned to this monitor.
- **MASK:** Subnet mask corresponding to the LAN
- **GATEWAY:** LAN gateway
- **DNS:** DNS server address of the LAN. In case of doubt, we recommend using the default value 8.8.8.8

After all data has been entered correctly, a confirmation message “SETTING SAVED” will appear. Otherwise, re-enter the data correctly.

SIP SETTINGS

Enter the SIP configuration data if the MEET monitor is to be used as a terminal in a SIP-based system such as a SIP server. Contact the SIP server administrator, who will provide you with the corresponding configuration data.

SIP SETTINGS	
ENABLE	<input type="checkbox"/>
SIP SERVER	
DOMAIN	
STUN IP	
STUN PORT	
SIP USER	
SIP PASS	

Use the on-screen keyboard to enter the SIP configuration data:

- **ENABLE:** Check this box if the SIP monitor is to be used as a SIP-based terminal.
- **SIP SERVER:** Enter the name or IP of the SIP server.
- **DOMAIN:** Enter the domain of the SIP server.
- **STUN IP:** Used for the configuration of large installations based on fibre optic links. Check with your network administrator.
- **STUN PORT:** Used for the configuration of SIP server-based installations. It is usually port 5060. Check with your network administrator.
- **USER:** Enter the SIP user number
- **SIP PASS:** Enter the SIP server user PASS.

NOTES:

Before programming the monitors, it is necessary to plan the installation with the following criteria:

- *Assign a unique IP to each element of the installation (including the PC where the MEET Management Software is installed, if any).*
- *All IP addresses must be in the same range.*
- *The LAN to be used must have an internet connection (if call forwarding to mobile is required) and be correctly configured.*

Consult your LAN administrator if you have any questions regarding the configuration of network parameters.

4.3. CONFIGURING THE ALARM SETTINGS

Touch the icon  to access the configuration parameters of the Alarm Centre incorporated in the monitor, according to the installation carried out. (See section 2.4 *Wiring of alarm and doorbell sensors*).



ZONE	TYPE	SENSOR	INPUT	DELAY
1	IMMEDIATE	PANIC	NC	0s
2	IMMEDIATE	PANIC	NC	0s
3	IMMEDIATE	PANIC	NC	0s
4	IMMEDIATE	PANIC	NC	0s
5	IMMEDIATE	PANIC	NC	0s
6	IMMEDIATE	PANIC	NC	0s
7	IMMEDIATE	PANIC	NC	0s

For each of the alarm zones indicate:

TYPE: Choose between INSTANT, DELAY or PANIC

- **INSTANT:** The alarm will be triggered at the same time as the corresponding sensor is activated.
- **DELAY:** The alarm will be triggered after the indicated time, to give the user time to switch it off.
- **PANIC:** The alarm will be triggered silently, i.e. by giving a warning to the control station, but without sounding on the monitor.

SENSOR: Choose the type of sensor used in this area, between SMOKE, GAS, MOTION, DOOR, WINDOW, PANIC, TAMPER and SOS.

This is the information that will appear on the monitor screen after the corresponding alarm is triggered.

INPUT: Choose between 3C, NA, NC or BELL.

- **3C:** If you have used the anti-tamper monitoring resistor in the sensor installation.
- **NA:** If a Normally Open type sensor has been used.
- **NC:** If a Normally Closed type sensor has been used.
- **TIMBRE:** If this area has been used to install a doorbell button.

DELAY: If a DELAY type sensor has been selected, select the required delay time from the options offered (0, 5, 15, 20, 25, 40 or 60 seconds).

MODES: Select the MODES in which you want each of the zones to be active, according to the type of sensor and the installation carried out.



ZONE	HOME	SLEEP	OUT
1	<input type="checkbox"/>	<input type="checkbox"/>	<input type="checkbox"/>
2	<input type="checkbox"/>	<input type="checkbox"/>	<input type="checkbox"/>
3	<input type="checkbox"/>	<input type="checkbox"/>	<input type="checkbox"/>
4	<input type="checkbox"/>	<input type="checkbox"/>	<input type="checkbox"/>
5	<input type="checkbox"/>	<input type="checkbox"/>	<input type="checkbox"/>
6	<input type="checkbox"/>	<input type="checkbox"/>	<input type="checkbox"/>
7	<input type="checkbox"/>	<input type="checkbox"/>	<input type="checkbox"/>
8	<input type="checkbox"/>	<input type="checkbox"/>	<input type="checkbox"/>

LOOP DETECT: Select this box if you want the system to monitor the status of the sensors every time you select NIGHT or OUT from the HOME mode.

In the event that a sensor in the NIGHT or OUT zones is activated, the user will be warned by a message on the screen. It will not be possible to change the mode until the incident has been corrected.

This makes it possible, for example, to avoid false alarms or security failures, if a door or window is left open at the time that NIGHT or OUT mode is selected.

4.4. ENABLE/DISABLE FUNCTIONS

Touch the icon  to select which functions are to be available to the user and which functions are to be blocked.

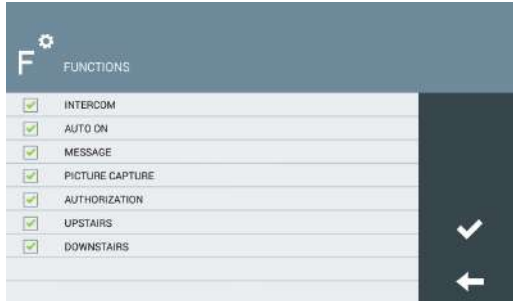

In the case of disabled functions, the corresponding icon will appear on the screen, but its use will be blocked, and a message will appear. "FUNCTION NOT ACTIVATED".

4.5. ENABLE/DISABLE FUNCTION ICONS ON THE MONITOR

MEET monitor has some several function ICONS that can be displayed or not on the main user interface. The ICONS by default are the following:

- CONCIERGE.
- AUTO ON
- EXTERCOM
- INTERCOM
- CALL LOG
- ALARM
- LIFT
- MESSAGE
- ACTUATORS
- SOS

You can select up to 8 ICONS to be available in the monitor.

Touch the icon  to access function ICONS section. There are 2 pages, that can be selected by means of the "arrow" icons.



Select which function ICON do you want be visible in the MAIN MENU.
 The MAIN MENU will show the 8 selected function ICONS.
 In the case of the selected function ICONS are less than 8 the rest will be blank.

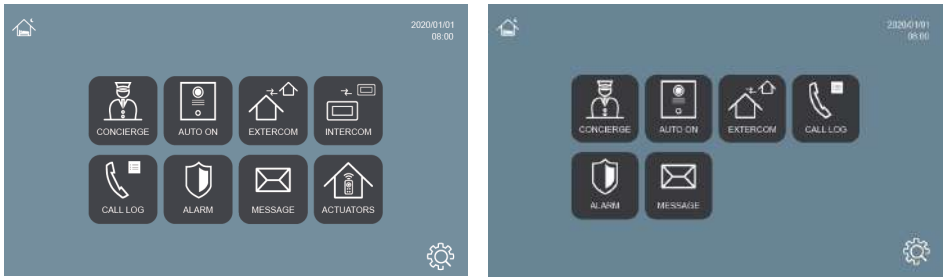

If a third party application (APP) has been installed, touch the icon  to enable a previously installed APP according to the procedure indicated in ANNEX 6.1. Installation of third party applications in this manual.

4.6. CHANGE INSTALLER PIN

To access the Installer Menu, you must identify yourself using an INSTALLER PIN, which by default is 6666.
 We advise you to change it for another of your choice. The new code must be 4 digits long. See NOTES.

Touch the icon  to change the INSTALLER PIN.



Use the numeric keypad to identify yourself with the current PIN and enter the new PIN. Confirmation of the new PIN is requested for security purposes.

NOTES:
 If the INSTALLER PIN is changed via WEB browser it can be longer and contain alphanumeric characters (See section 5.9 PIN CODE). But in that case, it cannot be used to access the configuration from the monitor itself.
 Make a note of the new PIN at your convenience. If you lose or forget your PIN, you should contact FERMAX's Technical Department to receive instructions regarding its recovery. All the monitor programming will be lost.



WEB BROWSER PROGRAMMING

For complete programming of the MEET monitor, access is required through a PC via a web browser.

The PC must be connected to the same LAN as the monitor and configured with an IP address in the same range.

The MEET monitors' default IP address is 10.1.1.1. However, this address can be changed or consulted via the local programming of the monitor. See section 4.2 Basic configuration of the MONITOR.

Type the IP address of the monitor in the address bar of the browser.

An identification form will appear.

Sign in

http://10.1.1.1

Your connection to this site is not private

Username

Password

The default identification data are:

- **User name:** admin
- **Password:** 6666

A form will appear with the different programming sections:

FERMAX

MEET VIDEO DOOR ENTRY SYSTEM

DEVICE DEVICE INFO

GENERAL

NETWORK

IP CAMERA

SIP

ADVANCED

ACTUATORS

VERIFICATION

PINCODE

RESTORE

FERMAX MEET MONITOR
 FIRMWARE: V03.00
 DEVICE: 065-0603-0
 MAC: BC:F8:11:0B:D1:2C
 IP: 200.200.200.53
 COPYRIGHT © FERMAX ELECTRONICA S.A.U
 www.fermax.com

PROGRAMMING SECTIONS

NOTES:

Preferably use the Chrome browser.

For WIT 10" monitors only programming via LAN#1 is possible.

The default identification data may have been changed from the local programming of the monitor.

5.1. DEVICE

Provides some technical information regarding the equipment, as a reference.

- **FIRMWARE:** Version of the installed firmware.
- **DEVICE:** Block-Apartment No.-Monitor No.
- **MAC:** Monitor MAC number.
- **IP:** IP address assigned to the monitor.

5.2. GENERAL

Allows the configuration of the identification parameters of the monitor within the installation.

FERMAX
MEET VIDEO DOOR ENTRY SYSTEM

GENERAL SETTINGS

BLOCK: 06
APARTMENT: 663
MONITOR: 0
DEVICE TAG: 123456 (≤ 16 CHARACTERS)
SYNC CODE: 123456
NUMBER OF CONCIERGES: 2
CONCIERGE 1 TAG: CENTRAL ROOM
CONCIERGE 2 TAG: EAST ENTRANCE
SAVE

- **BLOCK:** Block number of the apartment where the monitor is installed. 3 digits (001-009).

- **APART:** Number of the apartment where the monitor is installed. 4 digits (0001-9899).

- **MONITOR:** Number (from 0 to 9) assigned to each of the monitors installed in the same apartment, if there are several. If there is only one, leave the default value "0".

- **DEVICE TAG:** Name that will be shown in the monitor when the

function INTERCOM is being used.

- **SYNC CODE:** Synchronisation code with the rest of the monitors installed in the same home. It has to be the same in all of them. Default 123456.
- **NUMBER OF CONCIERGES.** Choose between 0 and 9 the number of concierges that will be available for this monitor. Depending on the selected number, some additional fields, to identify the corresponding concierges will appear below.
- **CONCIERGE X:** Select the GU number to call.
- **TAG:** Name that will be shown in the monitor when a call to concierge is being made.

Enter the corresponding parameters and click on SAVE to confirm.

NOTE: Before setting these parameters it is necessary to plan the installation (installation project) in advance, considering the configuration of all the devices.

5.3. NETWORK CONFIGURATION

Allows the configuration of the different parameters of the LAN network.

FERMAX
MEET VIDEO DOOR ENTRY SYSTEM

NETWORK SETTINGS

IP: 192.168.1.101
MASK: 255.255.255.0
GATEWAY: 192.168.1.1
DNS: 8.8.8.8
SOFTWARE IP: 10.0.0.200
SW. PIN: *****
SAVE

IP: IP address to be assigned to this monitor.

MÁSCARA: Subnet mask corresponding to the LAN.

MASK: LAN gateway.

DNS: DNS server address. In case of doubt, we recommend using the default value 8.8.8.8.

SOFTWARE IP: IP address of the PC where the MEET Management Software is installed (if any).

SOFTWARE PIN: PIN ACCESS code for the Management Program control. The default setting is 123456. Indicate the corresponding parameters and click on SAVE to confirm.

NOTE:

The MEET system uses static IP addressing. This ensures that each device has a unique IP address in the same installation.

If a device has an IP address already assigned to another device on the network, an “IP CONFLICT” prompt will appear, along with the MAC of the conflicting device.

Both devices will not work properly until this issue is resolved.

5.4. IP CAMERA

Designate the IP camera or cameras, accessible on the NETWORK, that will be available for viewing on this monitor.



- **CAMERA No:** Select the number of cameras to be designated, between 0 and 8. The form will be adapted to the number of selected cameras.

For each camera selected, indicate:

- o **Name** that will appear on the monitors during the display of the camera, for better identification
- o **CCTV RELAY:** Indicate if this camera will have any associated relay (between 1 and 4), which will allow activation of any additional device (door opening, etc.). The configuration of the relay is done when programming of ACCESS PANEL 1 of the corresponding block.
- o **URL:** RTSP path of the selected camera.

DOORBELL CAMERA : If a “doorbell” has been installed on the monitor (see installation section), this drop-down will indicate which camera (1, 2 or none) is associated with it (it will light up when someone rings the doorbell).

NOTE:

The RTSP route generally has the following format:

rtsp://usuario:contraseña@dirección_IP_de_la_cámara

although it depends on the configuration, brand and model of the camera itself. Please refer to the corresponding data sheet or technical information.

The CCTV RELAY function requires the installation of a 4-Relay MEET Module Ref. 1491 installed on panel nº 1 of the corresponding block. See Panel Installation Manual.

5.5. SIP

Use this setting to configure the SIP monitor as a SIP protocol-based terminal in cases where the monitor is to be configured as a terminal associated with a SIP server.

The available options are:

ACTIVATE SIP: Check this box if the SIP monitor is to be used as a SIP protocol-based terminal.

SEARCH SIP STATUS: This button appear when enable SIP function , show SIP REGISTERED if the panel register successfully or SIP REGISTER FAILED if the panel register unsuccessfully.

SIP SERVER: Enter the name or IP of the SIP server.

DOMAIN: Enter the domain of the SIP server.

OUTBOUND, STUN IP: Used for the configuration of large installations based on fibre optic links. Check with your network administrator.

STUN PORT: Used for the configuration of SIP server-based installations. It is usually port 5060. Check with your network administrator.

USER: Enter the SIP user number.

• **SIP PASS:** Enter the SIP server access PASS.

• **CONVERSATION:** Indicate the maximum conversation time in communications with SIP protocol.

NOTE:

The MEET monitor must be registered with the corresponding SIP server. Contact the server administrator for the necessary configuration data.



5.6. ADVANCED

The MEET monitors allow you to divert your calls to other devices such as:

- Other MEET monitors in the installation
- SIP devices
- Mobile phones (via MEET-ME APP)

EXT. SIP: Use this drop-down to set up call forwarding from this monitor to other devices (NONE, 1, 2, 3 or 4). The form will be automatically adapted depending on the number chosen.

Indicate the URL or URLs of the devices to which the calls will be forwarded. These URLs must have one of these formats:

- **sip: n° de username@sip.fermax.com**, in case of diversions to mobile using the MEET-ME APP, where username corresponds to the parameter username of the MEET-ME account installed in the mobile.
- **sip: XXX@dirección_ip**, in the case of diversions to MEET devices in the installation itself, where XXX is the device number and IP_address is the IP address of that device.
- **sip: user@dominio_servidor_sip**, in case of diversions to a third party SIP device.

AUTO ANSWER: Check this box if you want the monitor to automatically pick up when a call is received, if it is not answered manually within 10 seconds.

UN (GPON): Used in large installations based on SIP protocol (GPON) and in combination with the configuration of said installations.

DTMF UNLOCK: Generally, panels using SIP protocol require a number or combination of DTMF numbers to activate the associated door opener.

Select this box if the MEET monitor is used in combination with a panel that uses SIP protocol.

ACCESS PIN: Indicate the DTMF number (or combination of numbers) to be generated when the monitor's door open button is pressed, to activate the calling SIP panel's door opener. They can be numeric characters and special characters such as # or *.

No. OF DOOR LOCKS: Indicate the number of door openers that this monitor will control. (Between 0 and 4). Depending on the number indicated, the monitor screen will display additional door icons when you receive a call.

NUMBER OF CAMERAS: Numbers of IP cameras related to the panel, that will be available to switch during panel call. (0-4 optional).



ADDITIONAL DOORS

MAIN DOOR

NOTE

Additional door openers are connected to a 4-Relay Meet Module Ref. 1491 connected to panel n° 1 of the block where the monitor is installed (MILO DIGITAL ,MARINE MEET or KIN panels only).

5.7. ACTUATORS

Use this section to enable and name the actuators that this monitor can control.



Indicate (ACTIVATE) the relays to be enabled and write the name or description that should appear on the monitor when you want to control any of them.
 Select the desired activation time (between 1 and 60 seconds).
 Select SAVE to confirm.

NOTE:

The control of devices by means of actuators requires the module Ref. 1616. Its installation is explained in section 2.5. Wiring of FERMAX MEET Relay Module Ref. 1616.

5.8. CHECK

Functionality only useful for FERMAX personnel, both during the manufacturing process of the monitor and for the possible case in which some internal repair has to be carried out that involves substantial changes in the hardware of the equipment.

5.9. PIN CODE

Allows you to change the INSTALLER PIN code, to access both the installation configuration parameters through the monitor’s own screen and the configuration through a web browser.



Enter the current code, the new pin and confirm it.

The new password can have alphanumeric characters and has no limitation on its length. However, if the password does not contain just 4 numerical digits it cannot be used from the monitor interface.

Finally, select SAVE.

NOTES:

Make a note of the new PIN at your convenience. If you lose or forget your PIN, you should contact FERMAX's Technical Department to receive instructions regarding its recovery. All settings programmed into the monitor will be lost.

5.10. RESTORE

Use this functionality to remotely reset the monitor, or to return it to factory settings. In both cases it will ask for confirmation.

RESTORE FACTORY SETTINGS: The monitor will automatically turn off and start up with the factory settings:

GENERAL

- BLOCK: 1
- APARTMENT: 101
- MONITOR: 0

RED

- IP: 10.1.1.1
- GATEWAY: 10.254.0.1
- GATEWAY: 255.0.0.0
- INSTALLER PASSWORD: 6666



Any other parameters (sip, actuators, IP cameras, etc.) that have been configured will also be lost.

REBOOT DEVICE: The monitor will automatically turn off and start up, but retain all the programming parameters it had previously.

When resetting, the device will lose connection with the PC. Refresh the website after about 60 seconds to resume the connection.

ANNEXES

ANNEXES

6.1. INSTALLATION OF THIRD PARTY APPLICATIONS

In order to enable and use a third party APP, it must first be installed on the monitor.

The APP to be installed must be previously verified and signed by FERMAX ELECTRONICA. It is not possible to directly install APPs with *.apk format.

Contact FERMAX's After-Sales Service in the event that you wish to install a specific APP in a MEET monitor, to verify its viability.

If it is viable, you will receive two files with extension *.img, one of them to install the APP and another one of them to uninstall it if necessary.

The procedure to install or uninstall the APP through a PC connected to the same LAN as the monitor, and using the **MEET System Upgrading Tool.exe** program, is as follows:

1. Start:

MEET System Upgrading ToolV01.00.exe

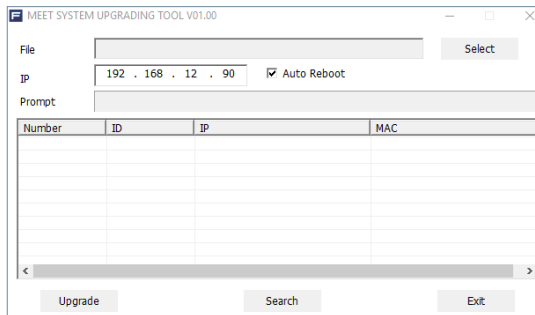

Number	ID	IP	MAC

2. Browse the PC to find the location of the *.img file corresponding to the installation of the APP.
3. Indicate the IP of the monitor
4. Select UPGRADE

The application will be installed in a few seconds, and will be ready to be enabled on the monitor, as explained in section 4.5 Enable third party APP.

NOTE:

*The process of uninstalling an APP is similar to the installation process, but using the uninstall *.img file.*

Use MEET System Upgrade Tool V1.2.exe instead of MEET System Upgrade Tool V1.00.exe for the installation of an APP on a batch of MEET monitors. Both programs can be downloaded from the FERMAX website.

6.2. FIRMWARE UPDATES

Sometimes it may be necessary or convenient to update a new firmware version because improvements or corrections have been incorporated into its operation.

FERMAX's Technical Department periodically informs (through Communications, Technical Bulletins, etc.) about the release of a new firmware update, as well as the improvements incorporated.

Contact the FERMAX Technical Department if you wish to receive the corresponding update file.

The firmware update is performed via the MEET System Upgrading Tool V01.00.exe.

The procedure for updating the firmware with the corresponding update file is as follows:

1. Start the **MEET System Upgrading Tool v1.00.exe**.

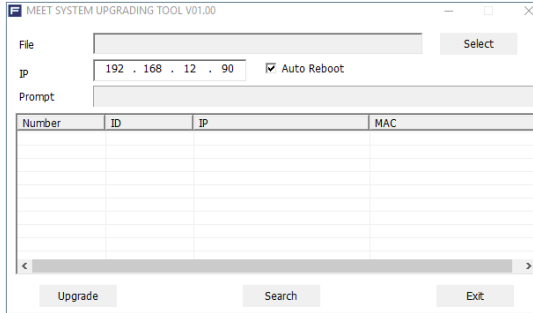

2. Browse the PC to find the location of the corresponding update file
3. Indicate the IP of the monitor
4. Select Upgrade.

NOTES

Use MEET System Upgrade Tool V1.2.exe instead of MEET System Upgrade Tool V1.00.exe to upgrade a batch of MEET monitors. Both programs can be downloaded from the FERMAX website.

REGULATIONS AND CERTIFICATION

This equipment has been tested and found to comply with the limits for a Class B digital device, pursuant to Part 15 of the FCC Rules. These limits are designed to provide reasonable protection against harmful interference in a residential installation. This equipment generates, uses, and can radiate radio frequency energy, and if not installed and used in accordance with the instructions, may cause harmful interference to radio communications. However, there is no guarantee that interference will not occur in a particular installation. If this equipment does cause harmful interference to radio or television reception, which can be determined by turning the equipment off and on, the user is encouraged to try to correct the interference by one or more of the following measures:

- Reorient or relocate the receiving antenna.
- Increase the separation between the equipment and receiver.
- Connect the equipment into an outlet on a circuit different from that to which the receiver is connected.
- Consult the dealer or an experienced radio/TV technician for help.





Avd. Tres Cruces, 133
46017 Valencia
Spain

For more information, visit www.fermax.com

Contact: tec@fermax.com / www.fermax.com/contact